



Anaesthesia
Narkose
Anesthesia
Anesthésie
Anestesia

**Tongue Holding Forceps**

Zungenzangen
Pinzas tira-lengua
Pincas tire-langue
Pinze tiralingua

Suction Tubes

Saugrohre
Tubos para aspiracion
Canules d'aspiration
Tubi aspirazione



03

**03-100-01**

1 Pair of rubber pads
1 paar Kautschukmatten
1 par de gomas de repuesto
1 paire de mors en caoutchouc
1 paio di mori di ricambio

YOUNG
03-100-17
17 cm, 6½"



COLLIN
03-110-17 17 cm, 6½"
03-110-19 19 cm, 7½"



03-114-15
15 cm, 6"

for infants
für Kleinkinder
para niños pequeños
pour nourissons
per neonati



03-114-20
20 cm, 8"

for children
für Kinder
para niños
pour enfants
per bambini



03-114-25
25 cm, 10"

for adults
für Erwachsene
para adultos
pour adultes
per adulti



MAGILL
03-114-15
03-114-25

Ø 10 mm



POOLE
03-120-22
22 cm, 8½"

Ø 8 mm



POOLE
03-121-22
22 cm, 8½"

Ø 10 mm

**03-126-01**

Suction basket only
Saugkopf allein
Cabezal para aspiración, suelto
Embout d'aspiration seul
Solo cestello aspirazione

YANKAUER
03-126-27
27 cm, 11"

Ø 9 mm

**03-128-01**

Suction basket only
Saugkopf allein
Cabezal para aspiración, suelto
Embout d'aspiration seul
Solo cestello aspirazione

DE BAKEY
03-128-28
28 cm, 11½"



MAUNDER
03-130-09
9,5 cm, 3¾"

Oral screw of wood
Mundkeil aus Holz
Garrote de madera
Bâillon en bois
Apribocca di legno



HEISTER
03-132-13
13 cm, 5"

Mouth gag
Mundsperrer
Abre-boca
Ouvre-bouches
Apribocca



MOLT
03-134-11 11 cm, 4½" (CHILD)
03-134-14 14 cm, 5½" (ADULT)

Mouth gag
Mundsperrer
Abre-boca
Ouvre-bouches
Apribocca



DENHART
03-136-12
12 cm, 4¾"

Mouth gag
Mundsperrer
Abre-boca
Ouvre-bouches
Apribocca

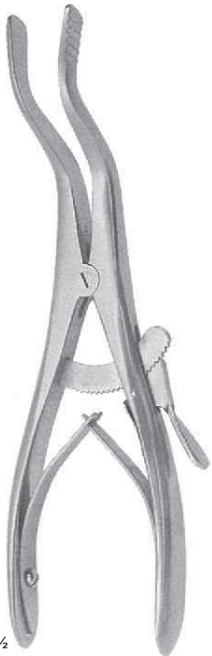

ROSER-KÖNIG
03-138-16 16 cm, 6¼"
03-138-19 19 cm, 7½"

Mouth gag
Mundsperrer
Abre-boca
Ouvre-bouches
Apribocca

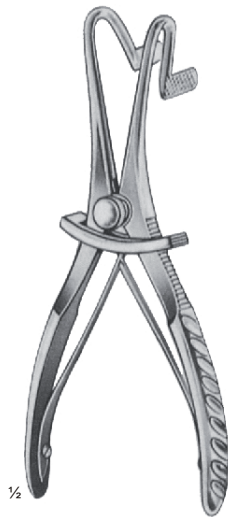

FERGUSON-ACKLAND
03-140-14
14,5 cm, 5¾"

Mouth gag
Mundsperrer
Abre-boca
Ouvre-bouches
Apribocca

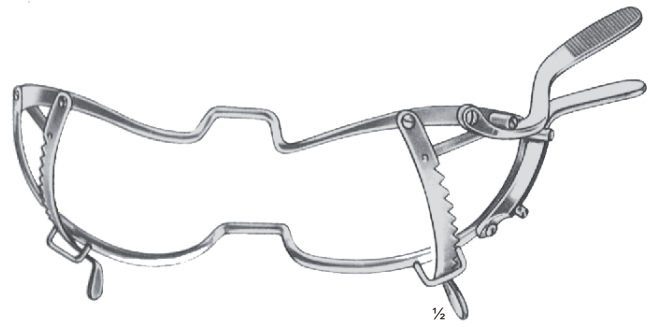

WHITEHEAD
03-150-11 11 cm, 4¼"
03-150-13 13 cm, 5"
03-150-15 15 cm, 6"

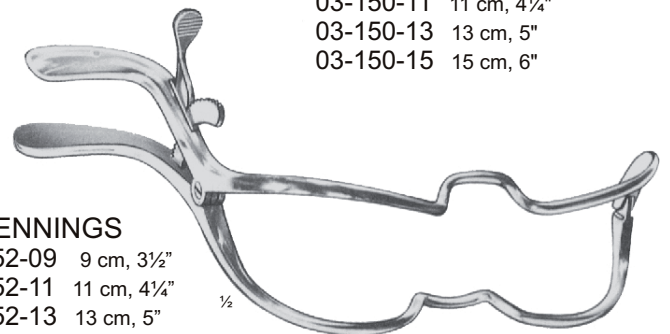

JENNINGS
03-152-09 9 cm, 3½"
03-152-11 11 cm, 4¼"
03-152-13 13 cm, 5"
03-152-15 15 cm, 6"

Mouth gag
Mundsperrer
Abre-boca
Ouvre-bouches
Apribocca



03-162-01 LEFT
 03-162-02 RIGHT



DAVIS BOYLE
 03-164-01 LEFT
 03-164-02 RIGHT



Mc LVOR
 03-166-00



SILICONE GUARD
 03-162-00



fig.		mm
01	03-168-00	20 x 25
02	03-168-01	20 x 35
03	03-168-1½	22 x 55
04	03-168-02	24 x 68
05	03-168-2½	24 x 72
06	03-168-03	24 x 83
07	03-168-3½	25 x 88
08	03-168-04	26 x 93
09	03-168-05	28 x 108



fig.		mm
01	03-170-01	20 x 35
02	03-170-1½	22 x 54
03	03-170-02	23 x 68
04	03-170-2½	23 x 72
05	03-170-03	24 x 83
06	03-170-3½	25 x 88
07	03-170-04	26 x 93
08	03-170-05	28 x 108



fig.		mm
01	03-172-01	20 x 35
02	03-172-1½	22 x 54
03	03-172-02	23 x 68
04	03-172-2½	23 x 72
05	03-172-03	24 x 83
06	03-172-3½	25 x 88
07	03-172-04	26 x 93
08	03-172-05	28 x 108



Laryngoscopes
 Laryngoskope
 Laringoscopios
 Laryngoscopes
 Laringoscopi



03

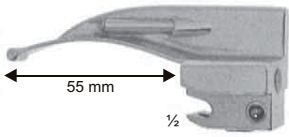

Fig.1
03-207-01

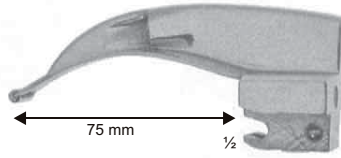

Fig.2
03-207-02

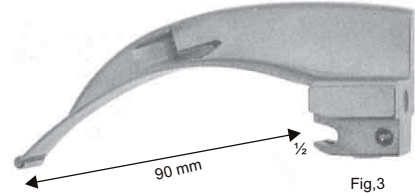

Fig.3
03-207-03

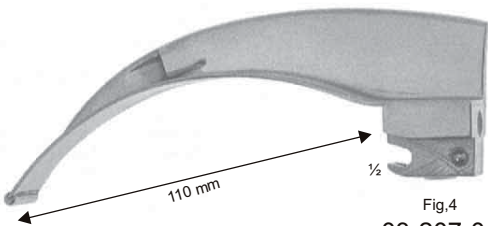

Fig.4
03-207-04

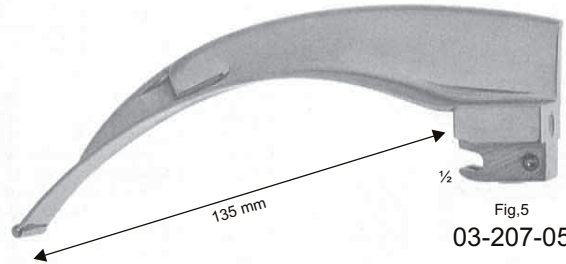

Fig.5
03-207-05



03-201-01
14,5 cm, 5 3/4"

Battery handle, ø 30 mm (2 Baby Batteries, 1,5 volt, are required)

Batteriegriff ø 30 mm (2 Baby-Zellen, 1,5 Volt, sind erforderlich)

Mango de pila ø 30 mm (se necesitan 2 pilas Mignon de 1,5 V)

Poignée à piles ø 30 mm (2 piles Mignon, 1,5 volts sont nécessaires)

Manico per pila ø 30 mm (2 pile Mignon di 1,5 volt sono necessarie)



03-203-01
14,5 cm, 5 3/4"

Battery handle, ø 30 mm (2 Baby Batteries, 1,5 volt, are required)

Batteriegriff ø 30 mm (2 Baby-Zellen, 1,5 Volt, sind erforderlich)

Mango de pila ø 30 mm (se necesitan 2 pilas Mignon de 1,5 V)

Poignée à piles ø 30 mm (2 piles Mignon, 1,5 volts sont nécessaires)

Manico per pila ø 30 mm (2 pile Mignon di 1,5 volt sono necessarie)



03-205-01
15 cm, 6"

Battery handle, ø 18 mm (2 Mini-Batteries, 1,5 volt, are required)

Batteriegriff ø 18 mm (2 Mini-Zellen, 1,5 Volt, sind erforderlich)

Mango de pila ø 18 mm (se necesitan 2 pilas Mini de 1,5 V)

Poignée à piles ø 18 mm (2 piles Mini, 1,5 volts sont nécessaires)

Manico per pila ø 18 mm (2 pile Mini di 1,5 volt sono necessarie)

McINTOSH

03-207-01
03-207-05

Laryngoscope blades
 Laryngoskopie-Spatel
 Espátulas de laringoscopios
 Spatules de laryngoscopie
 Spatole per laringoscopi



03-204-01
2,5 V



03-204-02
2,5 V



Laryngoscopes
Laryngoskope
Laringoscopios
Laryngoscopes
Laringoscopi



03

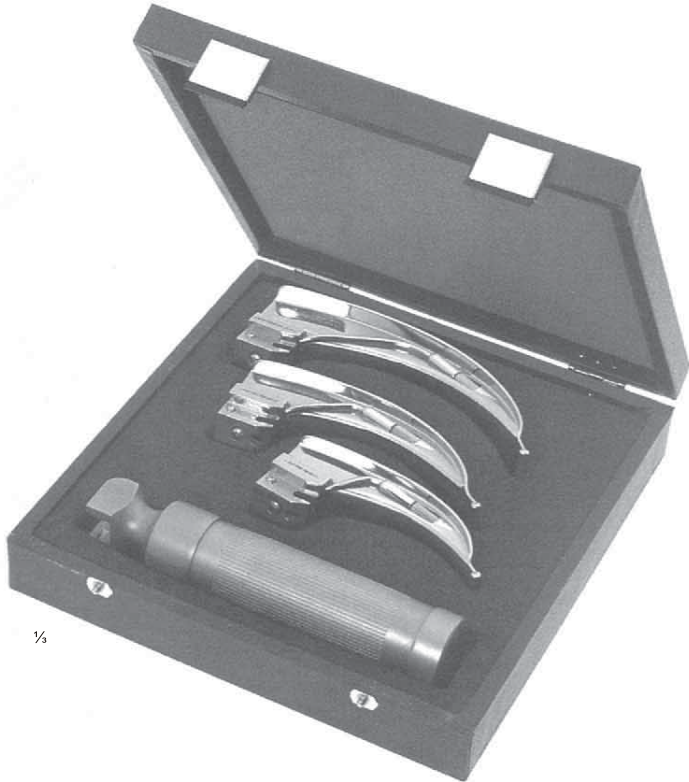

McINTOSH
03-207-00

Laryngoscope set, consisting of:

- 03-205-02 1 Laryngoscope blade 75 mm Fig.2
- 03-205-03 1 Laryngoscope blade 90 mm Fig.3
- 03-205-04 1 Laryngoscope blade 110 mm Fig.4
- 03-201-01 1 Battery handle, ø 30 mm (without batteries)
- 03-204-03 1 Case

Laryngoskopie-Besteck, bestehend aus:

- 03-205-02 1 Laryngoskopie-Spatel 75 mm Fig.2
- 03-205-03 1 Laryngoskopie-Spatel 90 mm Fig.3
- 03-205-04 1 Laryngoskopie-Spatel 110 mm Fig.4
- 03-201-01 1 Batteriegriff ø 30 mm (ohne Batterien)
- 03-204-03 1 Etui

Juego para laringoscopia, compuesto de:

- 03-205-02 1 Espátula de laringoscopia 75 mm Fig.2
- 03-205-03 1 Espátula de laringoscopia 90 mm Fig.3
- 03-205-04 1 Espátula de laringoscopia 110 mm Fig.4
- 03-201-01 1 Mango de pila ø 30 mm (sin pilas)
- 03-204-03 1 Estuche

Trousse à laryngoscopie, composée de:

- 03-205-02 1 Spatule pour laryngoscopie 75 mm Fig.2
- 03-205-03 1 Spatule pour laryngoscopie 90 mm Fig.3
- 03-205-04 1 Spatule pour laryngoscopie 110 mm Fig.4
- 03-201-01 1 Poignée à piles ø 30 mm (sans piles)
- 03-204-03 1 Boîte

Set per laringoscopia, composto da:

- 03-205-02 1 Spatola per laringoscopia 75 mm Fig.2
- 03-205-03 1 Spatola per laringoscopia 90 mm Fig.3
- 03-205-04 1 Spatola per laringoscopia 110 mm Fig.4
- 03-201-01 1 Manico per pila ø 30 mm (senza pila)
- 03-204-03 1 astuccio

McINTOSH
03-208-00

Laryngoscope set, consisting of:

- 03-205-02 1 Laryngoscope blade 75 mm Fig.2
- 03-205-03 1 Laryngoscope blade 90 mm Fig.3
- 03-205-04 1 Laryngoscope blade 110 mm Fig.4
- 03-205-05 1 Laryngoscope blade 135 mm Fig.5
- 03-201-01 1 Battery handle, ø 30 mm (without batteries)
- 03-204-03 1 Case

Laryngoskopie-Besteck, bestehend aus:

- 03-205-02 1 Laryngoskopie-Spatel 75 mm Fig.2
- 03-205-03 1 Laryngoskopie-Spatel 90 mm Fig.3
- 03-205-04 1 Laryngoskopie-Spatel 110 mm Fig.4
- 03-205-05 1 Laryngoskopie-Spatel 135 mm Fig.5
- 03-201-01 1 Batteriegriff ø 30 mm (ohne Batterien)
- 03-204-03 1 Etui

Juego para laringoscopia, compuesto de:

- 03-205-02 1 Espátula de laringoscopia 75 mm Fig.2
- 03-205-03 1 Espátula de laringoscopia 90 mm Fig.3
- 03-205-04 1 Espátula de laringoscopia 110 mm Fig.4
- 03-205-05 1 Espátula de laringoscopia 135 mm Fig.5
- 03-201-01 1 Mango de pila ø 30 mm (sin pilas)
- 03-204-03 1 Estuche

Trousse à laryngoscopie, composée de:

- 03-205-02 1 Spatule pour laryngoscopie 75 mm Fig.2
- 03-205-03 1 Spatule pour laryngoscopie 90 mm Fig.3
- 03-205-04 1 Spatule pour laryngoscopie 110 mm Fig.4
- 03-205-05 1 Spatule pour laryngoscopie 135 mm Fig.5
- 03-201-01 1 Poignée à piles ø 30 mm (sans piles)
- 03-204-03 1 Boîte

Set per laringoscopia, composto da:

- 03-205-02 1 Spatola per laringoscopia 75 mm Fig.2
- 03-205-03 1 Spatola per laringoscopia 90 mm Fig.3
- 03-205-04 1 Spatola per laringoscopia 110 mm Fig.4
- 03-205-05 1 Spatola per laringoscopia 135 mm Fig.5
- 03-201-01 1 Manico per pila ø 30 mm (senza pila)
- 03-204-03 1 astuccio

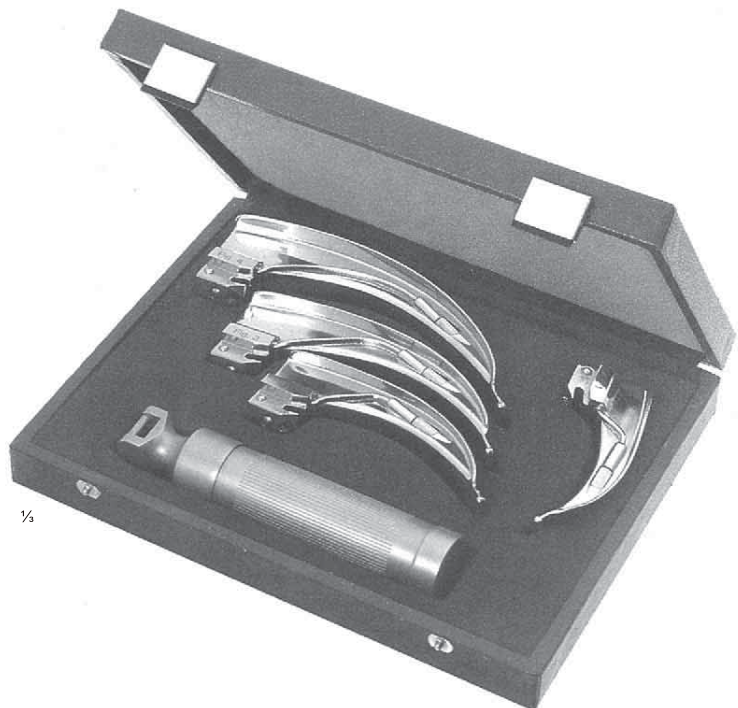



Laryngoscopes with Cold Light

Laryngoskope mit Kaltlicht
Laringoscopios de luz fría
Laryngoscopes lumière froide
Laringoscopi luce fredda



03

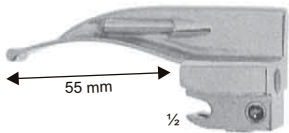

Fig. 1
03-215-01

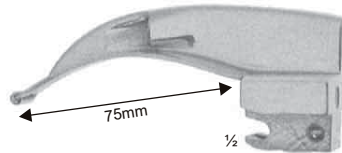

Fig. 2
03-215-02

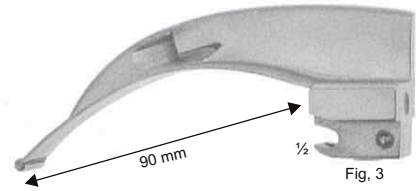

Fig. 3
03-215-03

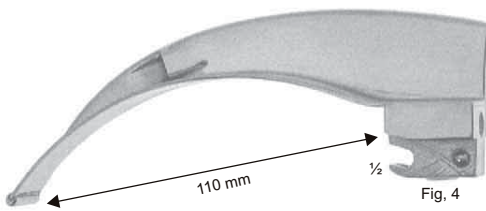

Fig. 4
03-215-04

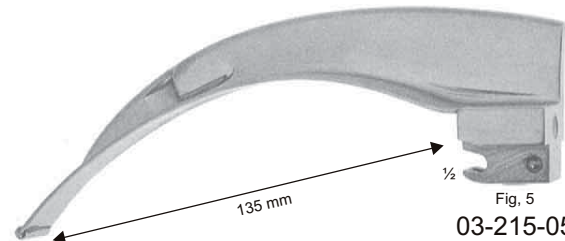

Fig. 5
03-215-05



03-211-01
16 cm, 6 1/4"

Battery handle, ø 30 mm (2 Baby batteries, 1,5 volt, are required)

Batteriegriff ø 30 mm (2 Baby-Zellen, 1,5 Volt, sind erforderlich)

Mango de pila ø 30 mm (se necesitan 2 pilas Mignon de 1,5 V)

Poignée à piles ø 30 mm (2 piles Mignon, 1,5 volts sont nécessaires)

Manico per pila ø 30 mm (2 pile Mignon di 1,5 volt sono necessarie)



03-213-01
16 cm, 6 1/4"

Battery handle, ø 18 mm (2 Mini batteries, 1,5 volt, are required)

Batteriegriff ø 18 mm (2 Mini-Zellen, 1,5 Volt, sind erforderlich)

Mango de pila ø 18 mm (se necesitan 2 pilas Mini de 1,5 V)

Poignée à piles ø 18 mm (2 piles Mini, 1,5 volts sont nécessaires)

Manico per pila ø 18 mm (2 pile Mini di 1,5 volt sono necessarie)

McINTOSH

03-215-01
03-215-05



Laryngoscope blades with integrated cold light carrier
Laryngoskopie-Spatel mit integriertem Kaltlichtträger
Espátulas de laringoscopios con luz fría integrada
Spatules de laryngoscopie, avec lumière froide inté
Spatole per laringoscopia, luce fredda



03-204-05
2,5 V



03-204-06
2,5 V

Halogen Lamp 2,5 V

Halogenlampe 2,5 V

Làmpara halógeno 2,5 V

Lampe halogène 2,5 V

Laryngoscopes with Cold Light

Laryngoskope mit Kaltlicht
Laringoscopios de luz fría
Laryngoscopes lumière froide
Laringoscopi luce fredda



03

McINTOSH 03-217-00

Laryngoscope set, consisting of:

- 03-215-02 1 Blade with cold light 80 mm Fig. 2
- 03-215-03 1 Blade with cold light 105 mm Fig.3
- 03-215-04 1 Blade with cold light 130 mm Fig.4
- 03-211-01 1 Battery Handle, ø 30 mm (without batteries)
- 03-204-03 1 Case

Laryngoskopie-Besteck, bestehend aus:

- 03-215-02 1 Spatel mit Kaltlicht 80 mm Fig. 2
- 03-215-03 1 Spatel mit Kaltlicht 105 mm Fig.3
- 03-215-04 1 Spatel mit Kaltlicht 130 mm Fig.4
- 03-211-01 1 Batteriegriff ø 30 mm (ohne Batterien)
- 03-204-03 1 Etui

Juego para laringoscopia, compuesto de:

- 03-215-02 1 Espátula con luz fría 80 mm Fig. 2
- 03-215-03 1 Espátula con luz fría 105 mm Fig.3
- 03-215-04 1 Espátula con luz fría 130 mm Fig.4
- 03-211-01 1 Mango de pila ø 30 mm (sin pilas)
- 03-204-03 1 Estuche

Trousse à laryngoscopie, composée de:

- 03-215-02 1 Spatule lumière froide 80 mm Fig. 2
- 03-215-03 1 Spatule lumière froide 105 mm Fig.3
- 03-215-04 1 Spatule lumière froide 130 mm Fig.4
- 03-211-01 1 Poignée à piles ø 30 mm (sans piles)
- 03-204-03 1 Boite

Set per laringoscopia, composto da:

- 03-215-02 1 Spatola con luce fredda 80 mm Fig. 2
- 03-215-03 1 Spatola con luce fredda 105 mm Fig.3
- 03-215-04 1 Spatola con luce fredda 130 mm Fig.4
- 03-211-01 1 Manico per pila ø 30 mm (senza pila)
- 03-204-03 1 astuccio



McINTOSH 03-218-00

Laryngoscope set, consisting of:

- 03-215-02 1 Blade with cold light 70 mm Fig. 2
- 03-215-03 1 Blade with cold light 80 mm Fig. 3
- 03-215-04 1 Blade with cold light 105 mm Fig.4
- 03-215-05 1 Blade with cold light 130mm Fig. 5
- 03-211-01 1 Battery Handle, ø 30 mm (without batteries)
- 03-204-03 1 Case

Laryngoskopie-Besteck, bestehend aus:

- 03-215-02 1 Spatel mit Kaltlicht 70 mm Fig. 2
- 03-215-03 1 Spatel mit Kaltlicht 80 mm Fig. 3
- 03-215-04 1 Spatel mit Kaltlicht 105 mm Fig.4
- 03-215-05 1 Spatel mit Kaltlicht 130 mm Fig.5
- 03-211-01 1 Batteriegriff ø 30 mm (ohne Batterien)
- 03-204-03 1 Etui

Juego para laringoscopia, compuesto de:

- 03-215-02 1 Espátula con luz fría 70 mm Fig. 2
- 03-215-03 1 Espátula con luz fría 80 mm Fig. 3
- 03-215-04 1 Espátula con luz fría 105 mm Fig.4
- 03-215-05 1 Espátula con luz fría 130 mm Fig.5
- 03-211-01 1 Mango de pila ø 30 mm (sin pilas)
- 03-204-03 1 Estuche

Trousse à laryngoscopie, composée de:

- 03-215-02 1 Spatule lumière froide 70 mm Fig. 2
- 03-215-03 1 Spatule lumière froide 80 mm Fig. 3
- 03-215-04 1 Spatule lumière froide 105 mm Fig.4
- 03-215-05 1 Spatule lumière froide 130 mm Fig.5
- 03-211-01 1 Poignée à piles ø 30 mm (sans piles)
- 03-204-03 1 Boite

Set per laringoscopia, composto da:

- 03-215-02 1 Spatola con luce fredda 70 mm Fig. 2
- 03-215-03 1 Spatola con luce fredda 80 mm Fig. 3
- 03-215-04 1 Spatola con luce fredda 105 mm Fig.4
- 03-215-05 1 Spatola con luce fredda 130 mm Fig.5
- 03-211-01 1 Manico per pila ø 30 mm (senza pila)
- 03-204-03 1 astuccio

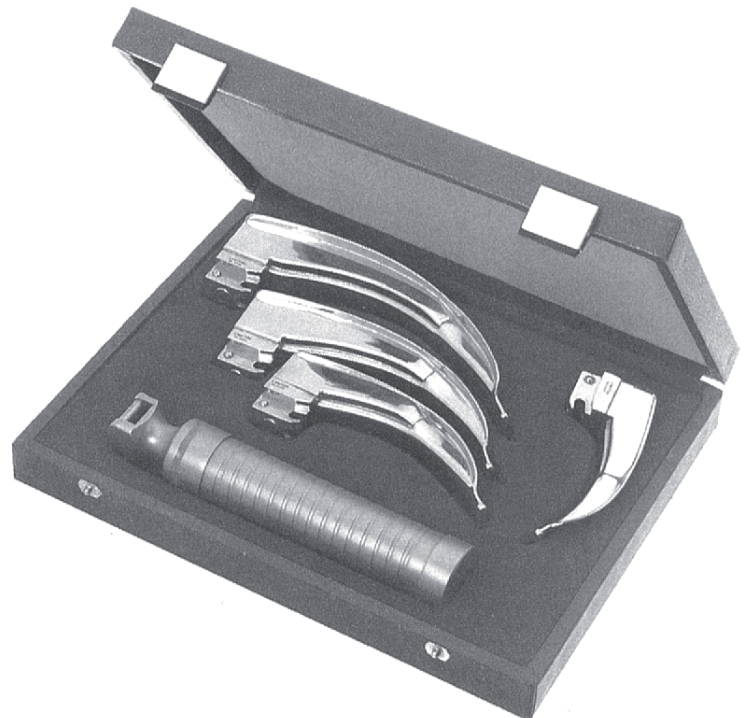



Laryngoscopes
 Laryngoskope
 Laringoscopios
 Laryngoscopes
 Laringoscopi



03

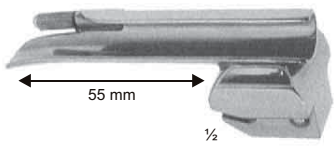

Fig. 1
03-225-01

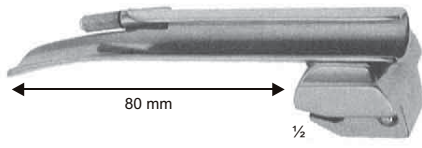

Fig. 2
03-225-02

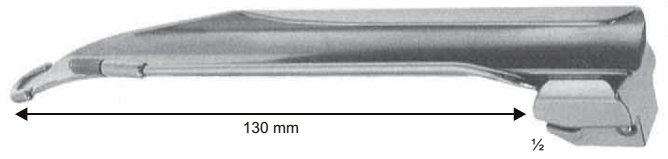

Fig. 3
03-225-03

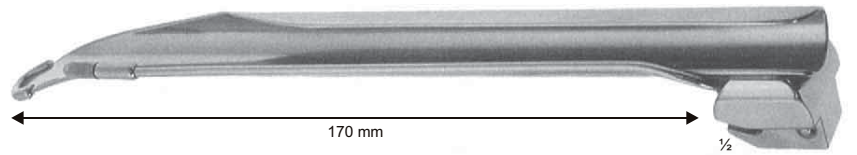

Fig. 4
03-225-04

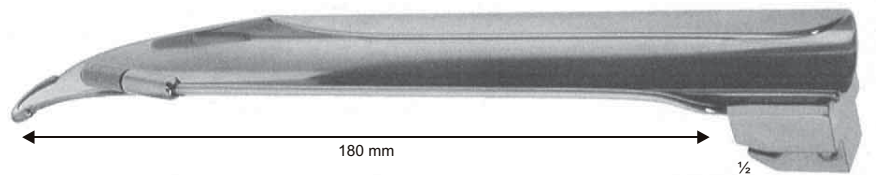

Fig. 5
03-225-05



03-201-01
14,5 cm, 5 3/4"

Battery handle, ø 30 mm (2 Baby Batteries, 1.5 volt, are required)

Batteriegriff ø 30 mm (2 Baby-Zellen, 1,5 Volt, sind erforderlich)

Mango de pila ø 30 mm (se necesitan 2 pilas Mignon de 1.5 V)

Poignée à piles ø 30 mm (2 piles Mignon, 1,5 volts sont nécessaires)

Manico per pila ø 30 mm (2 pile Mignon di 1.5 volt sono necessarie)



03-203-01
14,5 cm, 5 3/4"

Battery handle, ø 30 mm (2 Baby Batteries, 1.5 volt, are required)

Batteriegriff ø 30 mm (2 Baby-Zellen, 1,5 Volt, sind erforderlich)

Mango de pila ø 30 mm (se necesitan 2 pilas Mignon de 1.5 V)

Poignée à piles ø 30 mm (2 piles Mignon, 1,5 volts sont nécessaires)

Manico per pila ø 30 mm (2 pile Mignon di 1.5 volt sono necessarie)



03-205-01
15 cm, 6"

Battery handle, ø 18 mm (2 Mini-Batteries, 1.5 volt, are required)

Batteriegriff ø 18 mm (2 Mini-Zellen, 1,5 Volt, sind erforderlich)

Mango de pila ø 18 mm (se necesitan 2 pilas Mini de 1.5 V)

Poignée à piles ø 18 mm (2 piles Mini, 1,5 volts sont nécessaires)

Manico per pila ø 18 mm (2 pile Mini di 1.5 volt sono necessarie)

MILLER
03-225-01
03-225-05

Laryngoscope blades
 Laryngoskopie-Spatel
 Espátulas de laringoscopios
 Spatules de laryngoscopie
 Spatole per laringoscopi



03-204-01
2,5 V



03-204-02
2,5 V

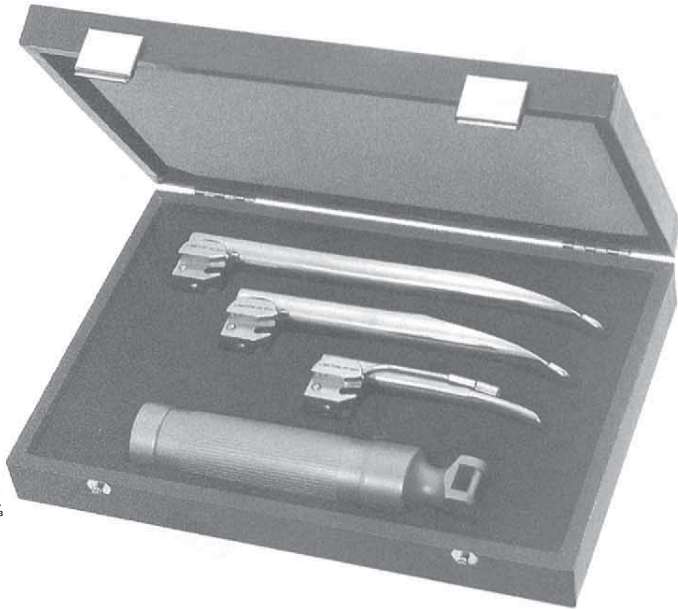

MILLER
03-227-00

Laryngoscope set, consisting of:
03-225-02 1 Laryngoscope blade 80 mm Fig.2
03-225-03 1 Laryngoscope blade 130 mm Fig.3
03-225-04 1 Laryngoscope blade 170 mm Fig.4
03-201-01 1 Battery handle, ø 30 mm (without batteries)
03-204-03 1 Case

Laryngoskopie-Besteck, bestehend aus:
03-225-02 1 Laryngoskopie-Spatel 80 mm Fig.2
03-225-03 1 Laryngoskopie-Spatel 130 mm Fig.3
03-225-04 1 Laryngoskopie-Spatel 170 mm Fig.4
03-201-01 1 Batteriegriff ø 30 mm (ohne Batterien)
03-204-03 1 Etui

Juego para laringoscopia, compuesto de:
03-225-02 1 Espátula de laringoscopia 80 mm Fig.2
03-225-03 1 Espátula de laringoscopia 130 mm Fig.3
03-225-04 1 Espátula de laringoscopia 170 mm Fig.4
03-201-01 1 Mango de pila ø 30 mm (sin pilas)
03-204-03 1 Estuche

Trousse à laryngoscopie, composée de:
03-225-02 1 Spatule pour laryngoscope 80 mm Fig.2
03-225-03 1 Spatule pour laryngoscope 130 mm Fig.3
03-225-04 1 Spatule pour laryngoscope 170 mm Fig.4
03-201-01 1 Poignée à piles ø 30 mm (sans piles)
03-204-03 1 Boîte

Set per laringoscopia, composto da:
03-225-02 1 Spatola per laringoscopia 80 mm Fig.2
03-225-03 1 Spatola per laringoscopia 130 mm Fig.3
03-225-04 1 Spatola per laringoscopia 170 mm Fig.4
03-201-01 1 Manico per pila ø 30 mm (senza pila)
03-204-03 1 astuccio

MILLER
03-228-00

Laryngoscope set, consisting of:
03-225-01 1 Laryngoscope blade 55 mm Fig.1
03-225-02 1 Laryngoscope blade 80 mm Fig.2
03-225-03 1 Laryngoscope blade 130 mm Fig.3
03-225-04 1 Laryngoscope blade 170 mm Fig.4
03-225-05 1 Laryngoscope blade 180 mm Fig.5
03-201-01 1 Battery handle, ø 30 mm (without batteries)
03-204-03 1 Case

Laryngoskopie-Besteck, bestehend aus:
03-225-01 1 Laryngoskopie-Spatel 55 mm Fig.1
03-225-02 1 Laryngoskopie-Spatel 80 mm Fig.2
03-225-03 1 Laryngoskopie-Spatel 130 mm Fig.3
03-225-04 1 Laryngoskopie-Spatel 170 mm Fig.4
03-225-05 1 Laryngoskopie-Spatel 180 mm Fig.5
03-201-01 1 Batteriegriff ø 30 mm (ohne Batterien)
03-204-03 1 Etui

Juego para laringoscopia, compuesto de:
03-225-01 1 Espátula de laringoscopia 55 mm Fig.1
03-225-02 1 Espátula de laringoscopia 80 mm Fig.2
03-225-03 1 Espátula de laringoscopia 130 mm Fig.3
03-225-04 1 Espátula de laringoscopia 170 mm Fig.4
03-225-05 1 Espátula de laringoscopia 180 mm Fig.5
03-201-01 1 Mango de pila ø 30 mm (sin pilas)
03-204-03 1 Estuche

Trousse à laryngoscopie, composée de:
03-225-01 1 Spatule pour laryngoscope 55 mm Fig.1
03-225-02 1 Spatule pour laryngoscope 80 mm Fig.2
03-225-03 1 Spatule pour laryngoscope 130 mm Fig.3
03-225-04 1 Spatule pour laryngoscope 170 mm Fig.4
03-225-05 1 Spatule pour laryngoscope 180 mm Fig.5
03-201-01 1 Poignée à piles ø 30 mm (sans piles)
03-204-03 1 Boîte

Set per laringoscopia, composto da:
03-225-01 1 Spatola per laringoscopia 55 mm Fig.1
03-225-02 1 Spatola per laringoscopia 80 mm Fig.2
03-225-03 1 Spatola per laringoscopia 130 mm Fig.3
03-225-04 1 Spatola per laringoscopia 170 mm Fig.4
03-225-05 1 Spatola per laringoscopia 180 mm Fig.5
03-201-01 1 Manico per pila ø 30 mm (senza pila)
03-204-03 1 astuccio





Laryngoscopes with Cold Light

Laryngoskope mit Kaltlicht
Laringoscopios de luz fria
Laryngoscopes lumière froide
Laringoscopi luce fredda



03

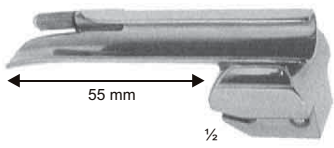

½

Fig. 1

03-235-01

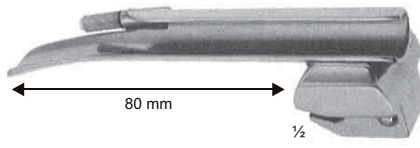

½

Fig. 2

03-235-02

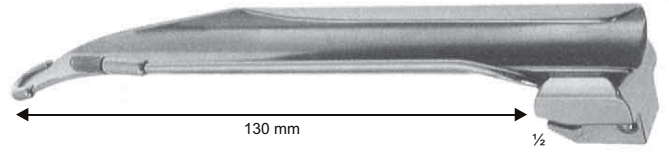

½

Fig. 3

03-235-03



½

Fig. 4

03-235-04

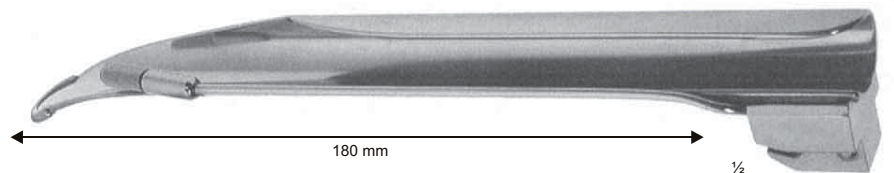

½

Fig. 5

03-235-05



½

03-211-01
14,5 cm, 5¾"

Battery handle, ø 30 mm (2 Baby Batteries, 1,5 volt, are required)

Batteriegriff ø 30 mm (2 Baby-Zellen, 1,5 Volt, sind erforderlich)

Mango de pila ø 30 mm (se necesitan 2 pilas Mignon de 1,5 V)

Poignée à piles ø 30 mm (2 piles Mignon, 1,5 volts sont nécessaires)

Manico per pila ø 30 mm (2 pile Mignon di 1,5 volt sono necessarie)



½

03-213-03
15 cm, 6"

Battery handle, ø 18 mm (2 Mini-Batteries, 1,5 volt, are required)

Batteriegriff ø 18 mm (2 Mini-Zellen, 1,5 Volt, sind erforderlich)

Mango de pila ø 18 mm (se necesitan 2 pilas Mini de 1,5 V)

Poignée à piles ø 18 mm (2 piles Mini, 1,5 volts sont nécessaires)

Manico per pila ø 18 mm (2 pile Mini di 1,5 volt sono necessarie)

MILLER
03-235-01
03-235-05



Laryngoscope blades with integrated cold light carrier
Laryngoskopie-Spatel mit integriertem Kaltlichtträger
Espátulas de laringoscopios con luz fría integrada
Spatules de laryngoscopie, avec lumière froide intégrée
Spatole per laringoscopia, luce fredda



¼

03-204-05
2,5 V



¼

03-204-06
2,5 V

Halogen Lamp 2,5 V
Halogenlampe 2,5 V
Lâmpara halógeno 2,5 V
Lampe halogène 2,5 V



Laryngoscopes with Cold Light
 Laryngoskope mit Kaltlicht
 Laringoscopios de luz fria
 Laryngoscopes lumière froide
 Laringoscopi luce fredda



03

MILLER
03-237-00

Laryngoscope set, consisting of:
 03-235-02 1 Laryngoscope blade 80 mm Fig.2
 03-235-03 1 Laryngoscope blade 130 mm Fig.3
 03-235-04 1 Laryngoscope blade 170 mm Fig.4
 03-211-01 1 Battery handle, ø 30 mm (without batteries)
 03-204-03 1 Case

Laryngoskopie-Besteck, bestehend aus:
 03-235-02 1 Laryngoskopie-Spatel 80 mm Fig.2
 03-235-03 1 Laryngoskopie-Spatel 130 mm Fig.3
 03-235-04 1 Laryngoskopie-Spatel 170 mm Fig.4
 03-211-01 1 Batteriegriff ø 30 mm (ohne Batterien)
 03-204-03 1 Etui

Juego para laringoscopia, compuesto de:
 03-235-02 1 Espátula de laringoscopia 80 mm Fig.2
 03-235-03 1 Espátula de laringoscopia 130 mm Fig.3
 03-235-04 1 Espátula de laringoscopia 170 mm Fig.4
 03-211-01 1 Mango de pila ø 30 mm (sin pilas)
 03-204-03 1 Estuche

Trousse à laryngoscopie, composée de:
 03-235-02 1 Spatule pour laryngoscopie 80 mm Fig.2
 03-235-03 1 Spatule pour laryngoscopie 130 mm Fig.3
 03-235-04 1 Spatule pour laryngoscopie 170 mm Fig.4
 03-211-01 1 Poignée à piles ø 30 mm (sans piles)
 03-204-03 1 Boîte

Set per laringoscopia, composto da:
 03-235-02 1 Spatola per laringoscopia 80 mm Fig.2
 03-235-03 1 Spatola per laringoscopia 130 mm Fig.3
 03-235-04 1 Spatola per laringoscopia 170 mm Fig.4
 03-211-01 1 Manico per pila ø 30 mm (senza pila)
 03-204-03 1 astuccio



1/3

MILLER
03-238-00

Laryngoscope set, consisting of:
 03-235-01 1 Laryngoscope blade 55 mm Fig.1
 03-235-02 1 Laryngoscope blade 80 mm Fig.2
 03-235-03 1 Laryngoscope blade 130 mm Fig.3
 03-235-04 1 Laryngoscope blade 170 mm Fig.4
 03-235-05 1 Laryngoscope blade 180 mm Fig.5
 03-211-01 1 Battery handle, ø 30 mm (without batteries)
 03-204-03 1 Case

Laryngoskopie-Besteck, bestehend aus:
 03-235-01 1 Laryngoskopie-Spatel 55 mm Fig.1
 03-235-02 1 Laryngoskopie-Spatel 80 mm Fig.2
 03-235-03 1 Laryngoskopie-Spatel 130 mm Fig.3
 03-235-04 1 Laryngoskopie-Spatel 170 mm Fig.4
 03-235-05 1 Laryngoskopie-Spatel 180 mm Fig.5
 03-211-01 1 Batteriegriff ø 30 mm (ohne Batterien)
 03-204-03 1 Etui

Juego para laringoscopia, compuesto de:
 03-235-01 1 Espátula de laringoscopia 55 mm Fig.1
 03-235-02 1 Espátula de laringoscopia 80 mm Fig.2
 03-235-03 1 Espátula de laringoscopia 130 mm Fig.3
 03-235-04 1 Espátula de laringoscopia 170 mm Fig.4
 03-235-05 1 Espátula de laringoscopia 180 mm Fig.5
 03-211-01 1 Mango de pila ø 30 mm (sin pilas)
 03-204-03 1 Estuche

Trousse à laryngoscopie, composée de:
 03-235-01 1 Spatule pour laryngoscopie 55 mm Fig.1
 03-235-02 1 Spatule pour laryngoscopie 80 mm Fig.2
 03-235-03 1 Spatule pour laryngoscopie 130 mm Fig.3
 03-235-04 1 Spatule pour laryngoscopie 170 mm Fig.4
 03-235-05 1 Spatule pour laryngoscopie 180 mm Fig.5
 03-211-01 1 Poignée à piles ø 30 mm (sans piles)
 03-204-03 1 Boîte

Set per laringoscopia, composto da:
 03-235-01 1 Spatola per laringoscopia 55 mm Fig.1
 03-235-02 1 Spatola per laringoscopia 80 mm Fig.2
 03-235-03 1 Spatola per laringoscopia 130 mm Fig.3
 03-235-04 1 Spatola per laringoscopia 170 mm Fig.4
 03-235-05 1 Spatola per laringoscopia 180 mm Fig.5
 03-211-01 1 Manico per pila ø 30 mm (senza pila)
 03-204-03 1 astuccio



1/3

Laryngoscopes

Laryngoskope
Laringoscopios
Laryngoscopes
Laringoscopi

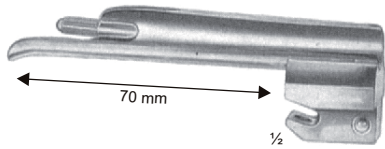

½

Fig. 1

03-245-01

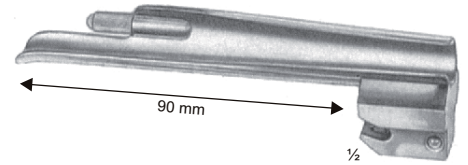

½

Fig. 2

03-245-02

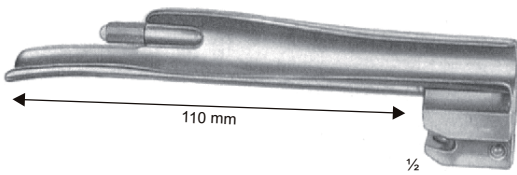

½

Fig. 2

03-245-03

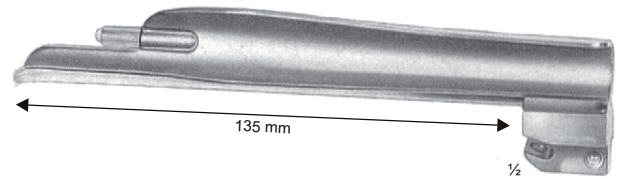

½

Fig. 4

03-245-04

FOREGGER

03-245-01

03-245-04



Laryngoscope blades
Laryngoskopie-Spatel
Espátulas de laringoscopios
Spatules de laryngoscopie
Spatole per laringoscopi

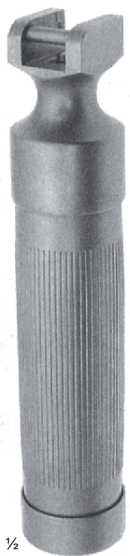

03-201-01
14,5 cm, 5¾"

Battery handle, ø 30 mm (2 Baby Batteries, 1,5 volt, are required)

Batteriegriff ø 30 mm (2 Baby-Zellen, 1,5 Volt, sind erforderlich)

Mango de pila ø 30 mm (se necesitan 2 pilas Mignon de 1,5 V)

Poignée e à piles ø 30 mm (2 piles Mignon, 1,5 volts sont nécessaires)

Manico per pila ø 30 mm (2 pile Mignon di 1,5 volt sono necessarie)



03-203-01
14,5 cm, 5¾"

Battery handle, ø 30 mm (2 Baby Batteries, 1,5 volt, are required)

Batteriegriff ø 30 mm (2 Baby-Zellen, 1,5 Volt, sind erforderlich)

Mango de pila ø 30 mm (se necesitan 2 pilas Mignon de 1,5 V)

Poignée e à piles ø 30 mm (2 piles Mignon, 1,5 volts sont nécessaires)

Manico per pila ø 30 mm (2 pile Mignon di 1,5 volt sono necessarie)



03-205-01
15 cm, 6"

Battery handle, ø 18 mm (2 Mini-Batteries, 1,5 volt, are required)

Batteriegriff ø 18 mm (2 Mini-Zellen, 1,5 Volt, sind erforderlich)

Mango de pila ø 18 mm (se necesitan 2 pilas Mini de 1,5 V)

Poigné e à piles ø 18 mm (2 piles Mini, 1,5 volts sont nécessaires)

Manico per pila ø 18 mm (2 pile Mini di 1,5 volt sono necessarie)



03-204-01
2,5 V



03-204-02
2,5 V



FOREGGER
03-248-00

Laryngoscope set, consisting of:

- 03-245-01 1 Laryngoscope blade 70 mm Fig.1
- 03-245-02 1 Laryngoscope blade 90 mm Fig.2
- 03-245-03 1 Laryngoscope blade 110 mm Fig.3
- 03-245-04 1 Laryngoscope blade 135 mm Fig.4
- 03-201-01 1 Battery handle, ø 30 mm (without batteries)
- 03-204-03 1 Case

Laryngoskopie-Besteck, bestehend aus:

- 03-245-01 1 Laryngoskopie-Spatel 70 mm Fig.1
- 03-245-02 1 Laryngoskopie-Spatel 90 mm Fig.2
- 03-245-03 1 Laryngoskopie-Spatel 110 mm Fig.3
- 03-245-04 1 Laryngoskopie-Spatel 135 mm Fig.4
- 03-201-01 1 Batteriegriff ø 30 mm (ohne Batterien)
- 03-204-03 1 Etui

Juego para laringoscopia, compuesto de:

- 03-245-01 1 Espátula de laringoscopia 70 mm Fig.1
- 03-245-02 1 Espátula de laringoscopia 90 mm Fig.2
- 03-245-03 1 Espátula de laringoscopia 110 mm Fig.3
- 03-245-04 1 Espátula de laringoscopia 135 mm Fig.4
- 03-201-01 1 Mango de pila ø 30 mm (sin pilas)
- 03-204-03 1 Estuche

Trousse à laryngoscopie, composée de:

- 03-245-01 1 Spatule pour laryngoscopie 70 mm Fig.1
- 03-245-02 1 Spatule pour laryngoscopie 90 mm Fig.2
- 03-245-03 1 Spatule pour laryngoscopie 110 mm Fig.3
- 03-245-04 1 Spatule pour laryngoscopie 135 mm Fig.4
- 03-201-01 1 Poignée à piles ø 30 mm (sans piles)
- 03-204-03 1 Boîte

Set per laringoscopia, composto da:

- 03-245-01 1 Spatola per laringoscopia 70 mm Fig.1
- 03-245-02 1 Spatola per laringoscopia 90 mm Fig.2
- 03-245-03 1 Spatola per laringoscopia 110 mm Fig.3
- 03-245-04 1 Spatola per laringoscopia 135 mm Fig.4
- 03-201-01 1 Manico per pila ø 30 mm (senza pila)
- 03-204-03 1 astuccio

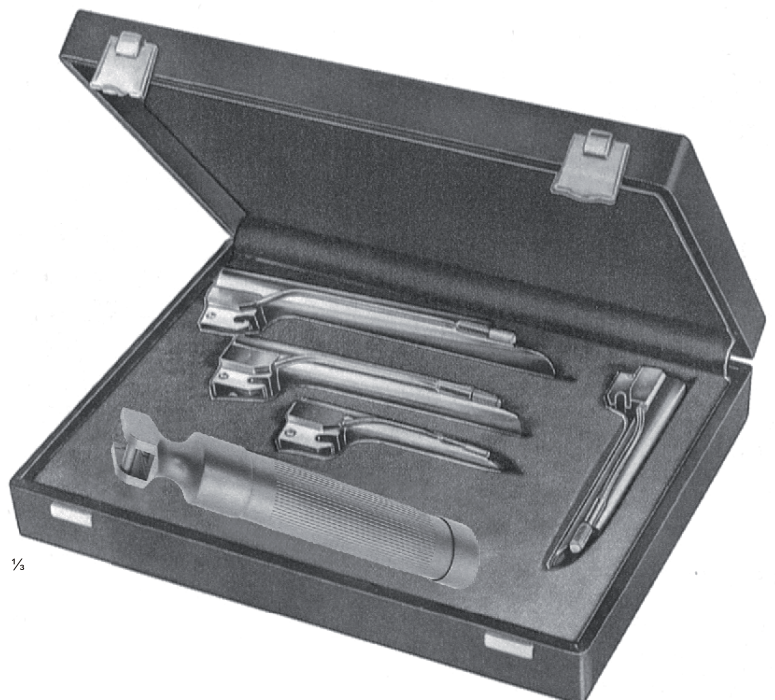

FOREGGER
03-247-00

Laryngoscope set, consisting of:

- 03-245-02 1 Laryngoscope blade 90 mm Fig.2
- 03-245-03 1 Laryngoscope blade 110 mm Fig.3
- 03-245-04 1 Laryngoscope blade 135 mm Fig.4
- 03-201-01 1 Battery handle, ø 30 mm (without batteries)
- 03-204-03 1 Case

Laryngoskopie-Besteck, bestehend aus:

- 03-245-02 1 Laryngoskopie-Spatel 90 mm Fig.2
- 03-245-03 1 Laryngoskopie-Spatel 110 mm Fig.3
- 03-245-04 1 Laryngoskopie-Spatel 135 mm Fig.4
- 03-201-01 1 Batteriegriff ø 30 mm (ohne Batterien)
- 03-204-03 1 Etui

Juego para laringoscopia, compuesto de:

- 03-245-02 1 Espátula de laringoscopia 90 mm Fig.2
- 03-245-03 1 Espátula de laringoscopia 110 mm Fig.3
- 03-245-04 1 Espátula de laringoscopia 135 mm Fig.4
- 03-201-01 1 Mango de pila ø 30 mm (sin pilas)
- 03-204-03 1 Estuche

Trousse à laryngoscopie, composée de:

- 03-245-02 1 Spatule pour laryngoscopie 90 mm Fig.2
- 03-245-03 1 Spatule pour laryngoscopie 110 mm Fig.3
- 03-245-04 1 Spatule pour laryngoscopie 135 mm Fig.4
- 03-201-01 1 Poignée à piles ø 30 mm (sans piles)
- 03-204-03 1 Boîte

Set per laringoscopia, composto da:

- 03-245-02 1 Spatola per laringoscopia 90 mm Fig.2
- 03-245-03 1 Spatola per laringoscopia 110 mm Fig.3
- 03-245-04 1 Spatola per laringoscopia 135 mm Fig.4
- 03-201-01 1 Manico per pila ø 30 mm (senza pila)
- 03-204-03 1 astuccio

Laryngoscopes with Cold Light

Laryngoskope mit Kaltlicht
Laringoscopios de luz fria
Laryngoscopes lumière froide
Laringoscopi luce fredda



03

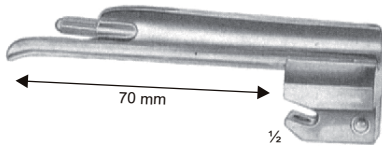

Fig. 1
03-255-01

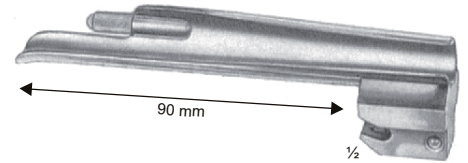

Fig. 2
03-255-02

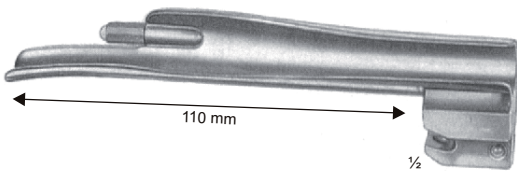

Fig. 3
03-255-03

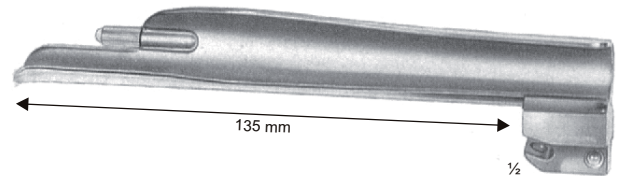

Fig. 4
03-255-04



03-211-01
16 cm, 6¼"

Battery handle, ø 30 mm (2 Baby batteries, 1,5 volt, are required)

Batteriegriff ø 30 mm (2 Baby-Zellen, 1,5 Volt, sind erforderlich)

Mango de pila ø 30 mm (se necesitan 2 pilas Mignon de 1,5 V)

Poignée à piles ø 30 mm (2 piles Mignon, 1,5 volts sont nécessaires)

Manico per pila ø 30 mm (2 pile Mignon di 1,5 volt sono necessarie)



03-213-03
16 cm, 6¼"

Battery handle, ø 18 mm (2 Mini batteries, 1,5 volt, are required)

Batteriegriff ø 18 mm (2 Mini-Zellen, 1,5 Volt, sind erforderlich)

Mango de pila ø 18 mm (se necesitan 2 pilas Mini de 1,5 V)

Poignée à piles ø 18 mm (2 piles Mini, 1,5 volts sont nécessaires)

Manico per pila ø 18 mm (2 pile Mini di 1,5 volt sono necessarie)

FOREGGER

03-255-01
03-255-04



Laryngoscope blades with integrated cold light carrier
Laryngoskopie-Spatel mit integriertem Kaltlichtträger
Espátulas de laringoscopios con luz fría integrada
Spatules de laryngoscopia, avec lumière froide intégrée
Spatole per laringoscopia, luce fredda

½

½

¼

¼

03-204-05
2,5 V

03-204-06
2,5 V

Halogen Lamp 2,5 V
Halogenlampe 2,5 V
Làmpara halógeno 2,5 V
Lampe halogène 2,5 V



Laryngoscopes with Cold Light
 Laryngoskope mit Kaltlicht
 Laringoscopios de luz fria
 Laryngoscopes lumière froide
 Laringoscopi luce fredda



03



FOREGGER
 03-257-00

Laryngoscope set, consisting of:
 03-255-02 1 Laryngoscope blade 90 mm Fig.2
 03-255-03 1 Laryngoscope blade 110 mm Fig.3
 03-255-04 1 Laryngoscope blade 135 mm Fig.4
 03-211-01 1 Battery handle, ø 30 mm (without batteries)
 03-204-03 1 Case

Laryngoskopie-Besteck, besteckedwnd aus:
 03-255-02 1 Laryngoskope-Spatel 90 mm Fig.2
 03-255-03 1 Laryngoskope-Spatel 110 mm Fig.3
 03-255-04 1 Laryngoskope-Spatel 135 mm Fig.4
 03-211-01 1 Batteriegriff ø 30 mm (ohne Batterien)
 03-204-03 1 Etui

Juego para laringoscopia, compuesto de:
 03-255-02 1 Espátula de laringoscopia 90 mm Fig.2
 03-255-03 1 Espátula de laringoscopia 110 mm Fig.3
 03-255-04 1 Espátula de laringoscopia 135 mm Fig.4
 03-211-01 1 Mango de pila ø 30 mm (sin pilas)
 03-204-03 1 Estuche

Trousse à laryngoscopie, composée de:
 03-255-02 1 Spatule pour laryngoscope 90 mm Fig.2
 03-255-03 1 Spatule pour laryngoscope 110 mm Fig.3
 03-255-04 1 Spatule pour laryngoscope 135 mm Fig.4
 03-211-01 1 Poignée à piles ø 30 mm (sans piles)
 03-204-03 1 Boîte

Set per laringoscopia composto da:
 03-255-02 1 Spatola per laringoscopia 80 mm Fig.2
 03-255-03 1 Spatola per laringoscopia 130 mm Fig.3
 03-255-04 1 Spatola per laringoscopia 170 mm Fig.4
 03-211-01 1 Manico per pila ø 30 mm (senza pila)
 03-204-03 1 astuccio

FOREGGER
 03-258-00

Laryngoscope set, consisting of:
 03-255-01 1 Laryngoscope blade 70 mm Fig.1
 03-255-02 1 Laryngoscope blade 90 mm Fig.2
 03-255-03 1 Laryngoscope blade 110 mm Fig.3
 03-255-04 1 Laryngoscope blade 135 mm Fig.4
 03-211-01 1 Battery handle, ø 30 mm (without batteries)
 03-204-03 1 Case

Laryngoskopie-Besteck, besteckend aus:
 03-255-01 1 Laryngoskope-Spatel 70 mm Fig.1
 03-255-02 1 Laryngoskope-Spatel 90 mm Fig.2
 03-255-03 1 Laryngoskope-Spatel 110 mm Fig.3
 03-255-04 1 Laryngoskope-Spatel 135 mm Fig.4
 03-211-01 1 Batteriegriff ø 30 mm (ohne Batterien)
 03-204-03 1 Etui

Juego para laringoscopia, compuesto de:
 03-255-01 1 Espátula de laringoscopia 70 mm Fig.1
 03-255-02 1 Espátula de laringoscopia 90 mm Fig.2
 03-255-03 1 Espátula de laringoscopia 110 mm Fig.3
 03-255-04 1 Espátula de laringoscopia 135 mm Fig.4
 03-211-01 1 Mango de pila ø 30 mm (sin pilas)
 03-204-03 1 Estuche

Trousse à laryngoscopie, composée de:
 03-255-01 1 Spatule pour laryngoscope 70 mm Fig.1
 03-255-02 1 Spatule pour laryngoscope 90 mm Fig.2
 03-255-03 1 Spatule pour laryngoscope 110 mm Fig.3
 03-255-04 1 Spatule pour laryngoscope 135 mm Fig.4
 03-211-01 1 Poignée à piles ø 30 mm (sans piles)
 03-204-03 1 Boîte

Set per laringoscopia composto da:
 03-255-01 1 Spatola per laringoscopia 70 mm Fig.1
 03-255-02 1 Spatola per laringoscopia 90 mm Fig.2
 03-255-03 1 Spatola per laringoscopia 110 mm Fig.3
 03-255-04 1 Spatola per laringoscopia 135 mm Fig.4
 03-211-01 1 Manico per pila ø 30 mm (senza pila)
 03-204-03 1 astuccio

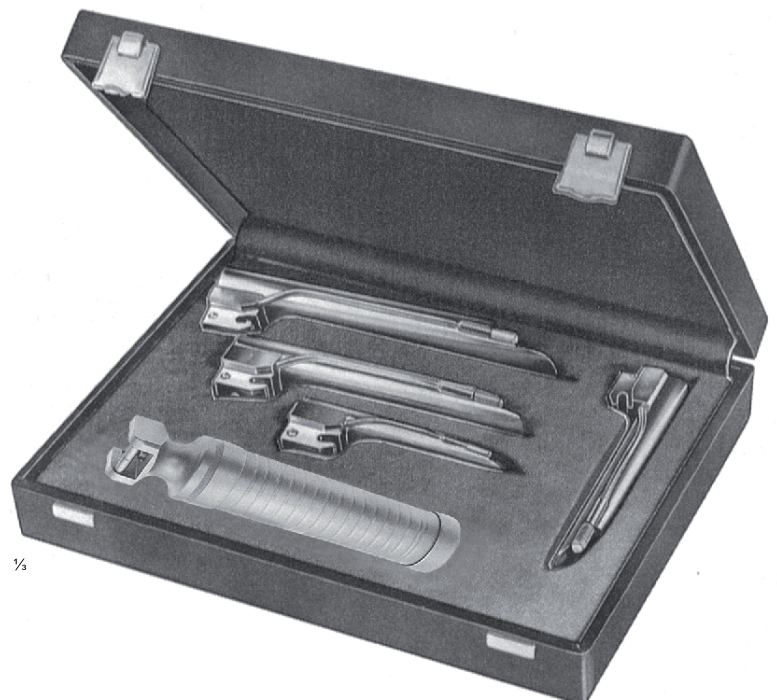

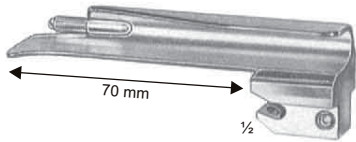

Fig.1
03-265-01

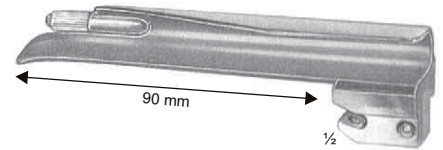

Fig.2
03-265-02

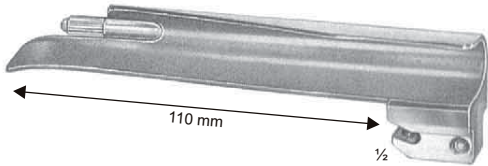

Fig.3
03-265-03

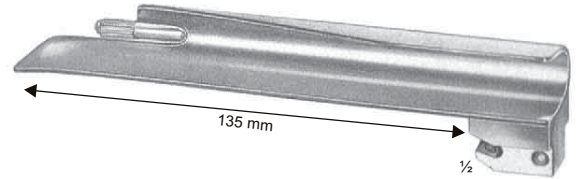

Fig.4
03-265-04



03-201-01
14,5 cm, 5 $\frac{3}{4}$ "

Battery handle, ø 30 mm (2 Baby Batteries, 1,5 volt, are required)

Batteriegriff ø 30 mm (2 Baby-Zellen, 1,5 Volt, sind erforderlich)

Mango de pila ø 30 mm (se necesitan 2 pilas Mignon de 1,5 V)

Poignée à piles ø 30 mm (2 piles Mignon, 1,5 volts sont nécessaires)

Manico per pila ø 30 mm (2 pile Mignon di 1,5 volt sono necessarie)



03-203-01
14,5 cm, 5 $\frac{3}{4}$ "

Battery handle, ø 30 mm (2 Baby Batteries, 1,5 volt, are required)

Batteriegriff ø 30 mm (2 Baby-Zellen, 1,5 Volt, sind erforderlich)

Mango de pila ø 30 mm (se necesitan 2 pilas Mignon de 1,5 V)

Poignée à piles ø 30 mm (2 piles Mignon, 1,5 volts sont nécessaires)

Manico per pila ø 30 mm (2 pile Mignon di 1,5 volt sono necessarie)



03-205-01
15 cm, 6"

Battery handle, ø 18 mm (2 Mini-Batteries, 1,5 volt, are required)

Batteriegriff ø 18 mm (2 Mini-Zellen, 1,5 Volt, sind erforderlich)

Mango de pila ø 18 mm (se necesitan 2 pilas Mini de 1,5 V)

Poignée à piles ø 18 mm (2 piles Mini, 1,5 volts sont nécessaires)

Manico per pila ø 18 mm (2 pile Mini di 1,5 volt sono necessarie)

GUEDEL-NEGUS
03-265-01
03-265-04

Laryngoscope blades
 Laryngoskopie-Spatel
 Espátulas de laringoscopios
 Spatules de laryngoscopie
 Spatole per laringoscopi



03-264-01
2,5 V



03-264-02
2,5 V

Laryngoscopes with Cold Light

Laryngoskope mit Kaltlicht
Laringoscopios de luz fria
Laryngoscopes lumière froide
Laringoscopi luce fredda



03



GUEDEL NEGUS 03-267-00

Laryngoscope set, consisting of:

- 03-265-02 1 Laryngoscope blade 90 mm Fig.2
- 03-265-03 1 Laryngoscope blade 110 mm Fig.3
- 03-265-04 1 Laryngoscope blade 135 mm Fig.4
- 03-201-01 1 Battery handle, ø 30 mm (without batteries)
- 03-204-03 1 Case

Laryngoskopie-Besteck, bestehend aus:

- 03-265-02 1 Laryngoskopie-Spatel 90 mm Fig.2
- 03-265-03 1 Laryngoskopie-Spatel 110 mm Fig.3
- 03-265-04 1 Laryngoskopie-Spatel 135 mm Fig.4
- 03-201-01 1 Batteriegriff ø 30 mm (ohne Batterien)
- 03-204-03 1 Etui

Juego para laringoscopia, compuesto de:

- 03-265-02 1 Espátula de laringoscopia 90 mm Fig.2
- 03-265-03 1 Espátula de laringoscopia 110 mm Fig.3
- 03-265-04 1 Espátula de laringoscopia 135 mm Fig.4
- 03-201-01 1 Mango de pila ø 30 mm (sin pilas)
- 03-204-03 1 Estuche

Trousse à laryngoscopie, composée de:

- 03-265-02 1 Spatule pour laryngoscope 90 mm Fig.2
- 03-265-03 1 Spatule pour laryngoscope 110 mm Fig.3
- 03-265-04 1 Spatule pour laryngoscope 135 mm Fig.4
- 03-201-01 1 Poignée à piles ø 30 mm (sans piles)
- 03-204-03 1 Boîte

Set per laringoscopia, composto da:

- 03-265-02 1 Spatola per laringoscopia 90 mm Fig.2
- 03-265-03 1 Spatola per laringoscopia 110 mm Fig.3
- 03-265-04 1 Spatola per laringoscopia 135 mm Fig.4
- 03-201-01 1 Manico per pila ø 30 mm (senza pila)
- 03-204-03 1 astuccio

GUEDEL NEGUS 03-268-00

Laryngoscope set, consisting of:

- 03-265-01 1 Laryngoscope blade 70 mm Fig.1
- 03-265-02 1 Laryngoscope blade 90 mm Fig.2
- 03-265-03 1 Laryngoscope blade 110 mm Fig.3
- 03-265-04 1 Laryngoscope blade 135 mm Fig.4
- 03-201-01 1 Battery handle, ø 30 mm (without batteries)
- 03-204-03 1 Case

Laryngoskopie-Besteck, bestehend aus:

- 03-265-01 1 Laryngoskopie-Spatel 70 mm Fig.1
- 03-265-02 1 Laryngoskopie-Spatel 90 mm Fig.2
- 03-265-03 1 Laryngoskopie-Spatel 110 mm Fig.3
- 03-265-04 1 Laryngoskopie-Spatel 135 mm Fig.4
- 03-201-01 1 Batteriegriff ø 30 mm (ohne Batterien)
- 03-204-03 1 Etui

Juego para laringoscopia, compuesto de:

- 03-265-01 1 Espátula de laringoscopia 70 mm Fig.1
- 03-265-02 1 Espátula de laringoscopia 90 mm Fig.2
- 03-265-03 1 Espátula de laringoscopia 110 mm Fig.3
- 03-265-04 1 Espátula de laringoscopia 135 mm Fig.4
- 03-201-01 1 Mango de pila ø 30 mm (sin pilas)
- 03-204-03 1 Estuche

Trousse à laryngoscopie, composée de:

- 03-265-01 1 Spatule pour laryngoscope 70 mm Fig.1
- 03-265-02 1 Spatule pour laryngoscope 90 mm Fig.2
- 03-265-03 1 Spatule pour laryngoscope 110 mm Fig.3
- 03-265-04 1 Spatule pour laryngoscope 135 mm Fig.4
- 03-201-01 1 Poignée à piles ø 30 mm (sans piles)
- 03-204-03 1 Boîte

Set per laringoscopia, composto da:

- 03-265-01 1 Spatola per laringoscopia 70 mm Fig.1
- 03-265-02 1 Spatola per laringoscopia 90 mm Fig.2
- 03-265-03 1 Spatola per laringoscopia 110 mm Fig.3
- 03-265-04 1 Spatola per laringoscopia 135 mm Fig.4
- 03-201-01 1 Manico per pila ø 30 mm (senza pila)
- 03-204-03 1 astuccio

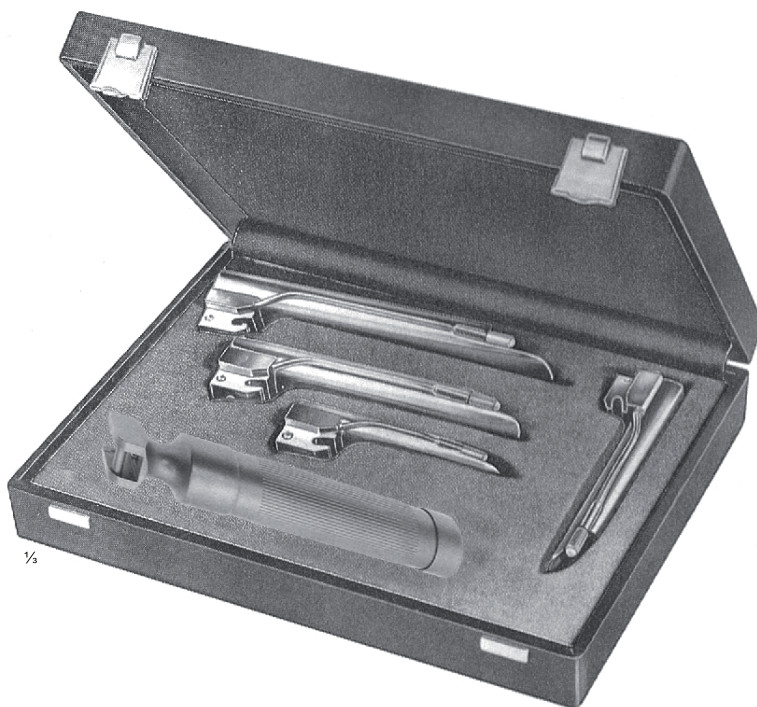

Laryngoscopes with Cold Light

Laryngoskope mit Kaltlicht
Laringoscopios de luz fria
Laryngoscopes lumière froide
Laringoscopi luce fredda



03

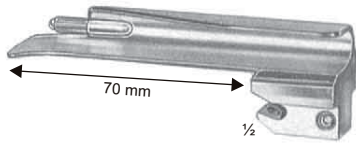

Fig.1
03-275-01

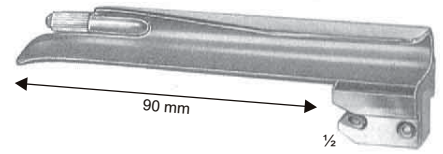

Fig.2
03-275-02

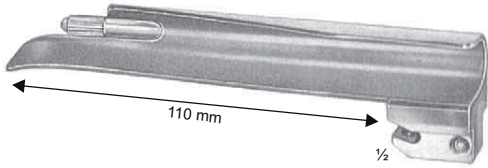

Fig.3
03-275-03

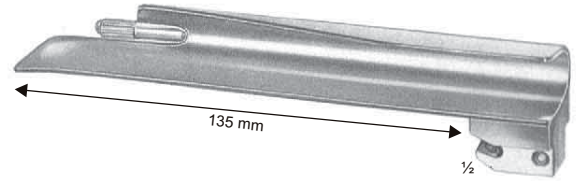

Fig.4
03-275-04



03-272-01
16 cm, 6¼"

Battery handle, ø 30 mm (2 Baby batteries, 1.5 volt, are required)

Batteriegriff ø 30 mm (2 Baby-Zellen, 1,5 Volt, sind erforderlich)

Mango de pila ø 30 mm (se necesitan 2 pilas Mignon de 1,5 V)

Poignée à piles ø 30 mm (2 piles Mignon, 1,5 volts sont nécessaires)

Manico per pila ø 30 mm (2 pile Mignon di 1,5 volt sono necessarie)



03-272-03
16 cm, 6¼"

Battery handle, ø 18 mm (2 Mini batteries, 1.5 volt, are required)

Batteriegriff ø 18 mm (2 Mini-Zellen, 1,5 Volt, sind erforderlich)

Mango de pila ø 18 mm (se necesitan 2 pilas Mini de 1,5 V)

Poignée à piles ø 18 mm (2 piles Mini, 1,5 volts sont nécessaires)

Manico per pila ø 18 mm (2 pile Mini di 1,5 volt sono necessarie)

GUEDEL-NEGUS

03-275-01
03-275-04



Laryngoscope blades with integrated cold light carrier
Laryngoskopie-Spatel mit integriertem Kaltlichtträger
Espátulas de laringoscopios con luz fria integrada
Spatules de laryngoscopie, avec lumiere froide inté
Spatole per laringoscopia, luce fredda



03-204-05
2,5 V



03-204-06
2,5 V

Halogen Lamp 2,5 V
Halogenlampe 2,5 V
Làmpara halógeno 2,5 V
Lampe halogène 2,5 V



GUEDEL-NEGUS
 03-278-00

Laryngoscope set, consisting of:
 03-275-01 1 Laryngoscope blade 70 mm Fig.1
 03-275-02 1 Laryngoscope blade 90 mm Fig.2
 03-275-03 1 Laryngoscope blade 110 mm Fig.3
 03-275-04 1 Laryngoscope blade 135 mm Fig.4
 03-211-01 1 Battery handle, ø 30 mm (without batteries)
 03-204-03 1 Case

Laryngoskopie-Besteck, bestehend aus:
 03-275-01 1 Laryngoskopie-Spatel 70 mm Fig.1
 03-275-02 1 Laryngoskopie-Spatel 90 mm Fig.2
 03-275-03 1 Laryngoskopie-Spatel 110 mm Fig.3
 03-275-04 1 Laryngoskopie-Spatel 135 mm Fig.4
 03-211-01 1 Batteriegriff ø 30 mm (ohne Batterien)
 03-204-03 1 Etui

Juego para laringoscopia, compuesto de:
 03-275-01 1 Espátula de laringoscopia 70 mm Fig.1
 03-275-02 1 Espátula de laringoscopia 90 mm Fig.2
 03-275-03 1 Espátula de laringoscopia 110 mm Fig.3
 03-275-04 1 Espátula de laringoscopia 135 mm Fig.4
 03-211-01 1 Mango de pila ø 30 mm (sin pilas)
 03-204-03 1 Estuche

Trousse à laryngoscopie, composée de:
 03-275-01 1 Spatule pour laryngoscope 70 mm Fig.1
 03-275-02 1 Spatule pour laryngoscope 90 mm Fig.2
 03-275-03 1 Spatule pour laryngoscope 110 mm Fig.3
 03-275-04 1 Spatule pour laryngoscope 135 mm Fig.4
 03-211-01 1 Poignée à piles ø 30 mm (sans piles)
 03-204-03 1 Boîte

Set per laringoscopia, composto da:
 03-275-01 1 Spatola per laringoscopia 70 mm Fig.1
 03-275-02 1 Spatola per laringoscopia 90 mm Fig.2
 03-275-03 1 Spatola per laringoscopia 110 mm Fig.3
 03-275-04 1 Spatola per laringoscopia 135 mm Fig.4
 03-211-01 1 Manico per pila ø 30 mm (senza pila)
 03-204-03 1 astuccio

GUEDEL-NEGUS
 03-277-00

Laryngoscope set, consisting of:
 03-275-02 1 Laryngoscope blade 90 mm Fig.2
 03-275-03 1 Laryngoscope blade 110 mm Fig.3
 03-275-04 1 Laryngoscope blade 135 mm Fig.4
 03-211-01 1 Battery handle, ø 30 mm (without batteries)
 03-204-03 1 Case

Laryngoskopie-Besteck, bestehend aus:
 03-275-02 1 Laryngoskopie-Spatel 90 mm Fig.2
 03-275-03 1 Laryngoskopie-Spatel 110 mm Fig.3
 03-275-04 1 Laryngoskopie-Spatel 135 mm Fig.4
 03-211-01 1 Batteriegriff ø 30 mm (ohne Batterien)
 03-204-03 1 Etui

Juego para laringoscopia, compuesto de:
 03-275-02 1 Espátula de laringoscopia 90 mm Fig.2
 03-275-03 1 Espátula de laringoscopia 110 mm Fig.3
 03-275-04 1 Espátula de laringoscopia 135 mm Fig.4
 03-211-01 1 Mango de pila ø 30 mm (sin pilas)
 03-204-03 1 Estuche

Trousse à laryngoscopie, composée de:
 03-275-02 1 Spatule pour laryngoscope 90 mm Fig.2
 03-275-03 1 Spatule pour laryngoscope 110 mm Fig.3
 03-275-04 1 Spatule pour laryngoscope 135 mm Fig.4
 03-211-01 1 Poignée à piles ø 30 mm (sans piles)
 03-204-03 1 Boîte

Set per laringoscopia, composto da:
 03-275-02 1 Spatola per laringoscopia 90 mm Fig.2
 03-275-03 1 Spatola per laringoscopia 110 mm Fig.3
 03-275-04 1 Spatola per laringoscopia 135 mm Fig.4
 03-211-01 1 Manico per pila ø 30 mm (senza pila)
 03-204-03 1 astuccio

